

# Installation Guidelines

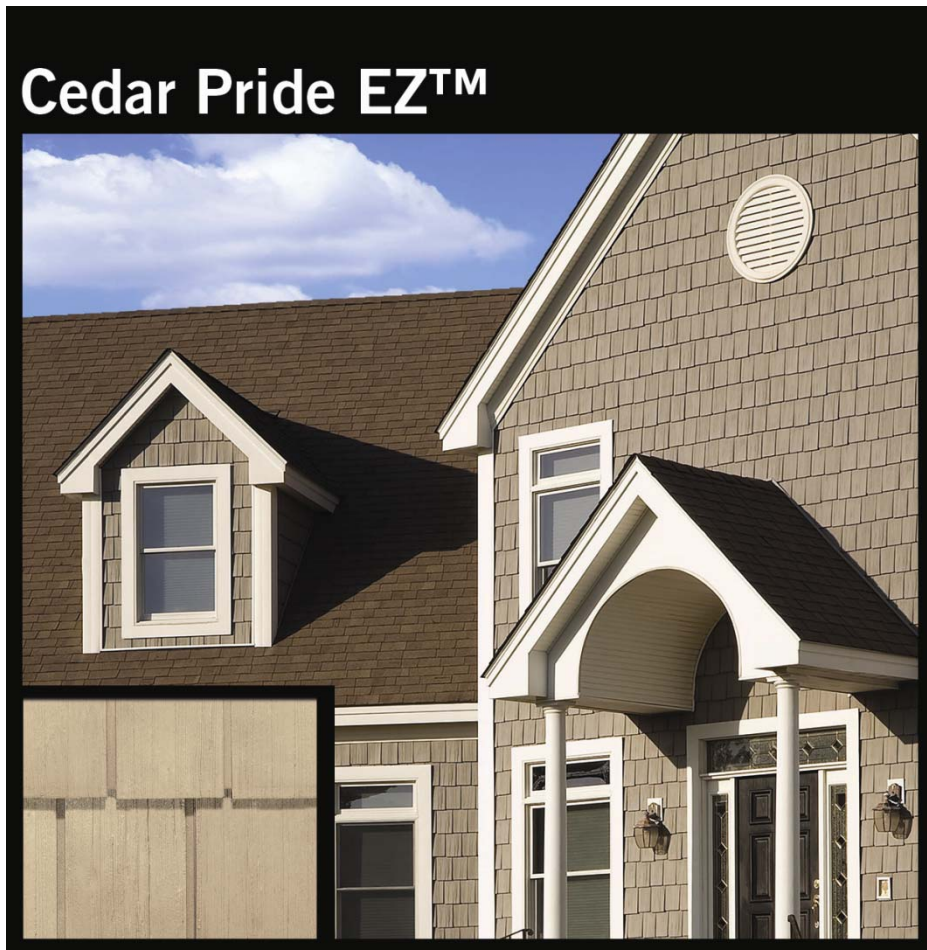

Exteria provides these instructions as installation guidelines. Exteria, however, neither installs the panels nor has any control over the installation. It is the responsibility of the contractor and/or the installer to ensure Exteria siding panels are installed in accordance with these instructions and any applicable building codes. Exteria assumes no liability for either improper installation or personal injury resulting from improper use or installation.

For more information on Exteria Building Products and its wide variety of state-of-the-art products, please call us at 877-EXTERIA (877-398-3742) or write: 1111 NW 165 Street, Miami, FL 33169-5819. Installation Guidelines can be downloaded from our website: [www.exteriabp.com](http://www.exteriabp.com).

## BASIC GUIDELINES

1. Always work from left to right installing one row at a time, and completing one wall before beginning another. Always start at the lowest point of the structure.
2. As with any plastic exterior building material, Exteria panels will expand and contract with a change in temperature. Therefore, during installation it is necessary to position the panels properly to compensate for temperature effects. When installing at panel temperatures from 30 to 100 degrees Fahrenheit, position the next panel so that its upper left edge is on the spacing line (Figure 1).

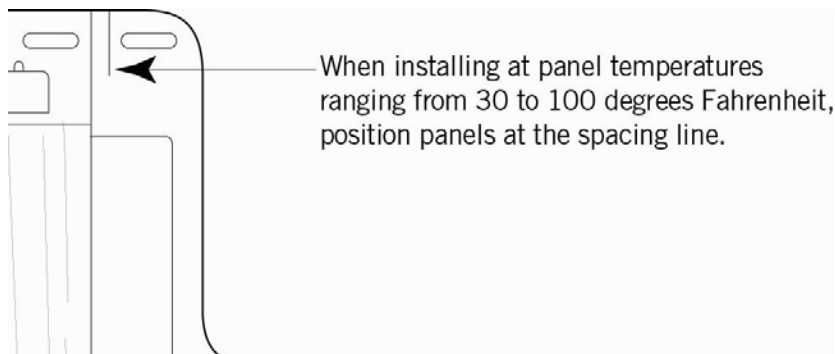

Figure 1

For installations at temperatures below 30 degrees F, position the next panel slightly right of the line (e.g. 3/16"). Allow a 1/4" spacing around all openings. Once the panel has been properly spaced, insert a fastener into the center hole of the panel. For easier installation in colder temperatures, store the panels in a heated area.

3. After positioning the panel at the proper spacing for the installation temperature, install a fastener into the center hole of the panel. By attaching a fastener through the center hole, the panel will move equally in both directions from the center out.
4. If the panel is a partial panel used at either end, a new hole should be created by drilling a 1/8" hole in the top flange, near the center of the panel at the same height as the other installation holes.
5. Exteria panels are intended for use in a vertical placement only and are not designed or warranted for roofing or flooring applications. However, mansard roofs with a 45/12 slope or greater are acceptable applications.
6. It is essential to work over a smooth, flat, nailable wall surface, (i.e. 7/16" OSB board or plywood is recommended). Refer to the respective furring strip installation guidelines if furring strips are utilized.

7. Non-corrosive fasteners are required to secure the panels and they must penetrate the solid substrate by at least 7/16”.
8. If face nailing is employed, pre-drill a hole in an inconspicuous area, such as a shingle seam. The hole must be larger than the shank of the nail or screw, but smaller than the head to allow for possible expansion. The head can be covered with matching paint.
9. Fastening the panels should not restrict panel movement. Fasteners should be driven straight into the center of any nailing slot making light contact with the panel, allowing the panel to be hung. The center nailing hole must always be nailed to ensure that the panel expands and contracts from the center out. It is best to work with the panels at waist-level, allowing the installer to inspect the back of the panels, verifying that all fingers are properly engaged.
10. Siding has always been designed as an exterior cladding, not a weather resistant barrier. Siding is designed to allow the material underneath it to breathe; therefore, it is not a watertight covering. To achieve designed performance, Exteria siding must be installed over a weather resistant house barrier system such as house wrap.
11. Store panels on edge; do not stack flat.
12. It is recommended to not install all corners at one time or you will lose the ability to adjust and properly align them to the panels. Cedar Pride EZ panels must be installed on all walls prior to installing the Cedar Pride corners.
13. Variations in shade and color are an inherent characteristic of Exteria weathered colors. Weathered means the variegated cedar panels (see brochure for specific colors). Installed siding is considered acceptance of product and no claims for aesthetic concerns will be honored after installation.

## INSTALLATION STEPS

**STEP ONE:** Install the starter strip at the lowest point of the structure. The structure's solid substrate must be no less than 7/16" thick. The strip should be positioned 2" from the wall corner allowing for the width of the corner piece. Nail the starter strips every 12" ensuring that the starter strip remains level (Figure 1a). A chalk line is recommended.

**STEP TWO:** If using molded Cedar Pride corners, install the corner starter clip (located inside each carton of corners) at this time. The starter clip and the starter strip are the same height and should be vertically aligned (Figure 1b). Be sure the starter clip opening is facing down (Figure 1c). Once aligned, attach two fasteners on each side of the clip. Cedar Pride corners overlap the installed siding. If using vinyl corner posts, install them now.

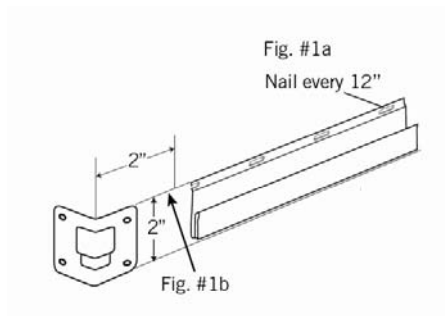

Figures 1a & 1b

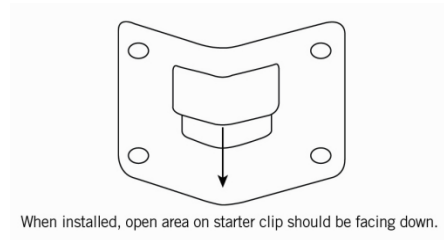

Figure 1c

**STEP THREE:** Determine the number of panels needed for the wall by measuring the total length of the wall in inches, subtracting 2" to accommodate the corner pieces and dividing by 72 3/8" (the width of one panel exposed to the weather). As you may need to cut the end panel, ensure that it remains at least 8" wide by reducing the length of the starting panel.

**STEP FOUR:** Working from left to right, hook the first panel underneath the face of the starter strip and slide it left, placing the panel approximately 2" from the wall corner. If you have inside corners, see Step Nine before installing panels.

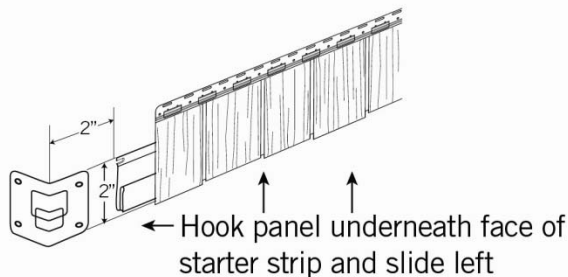

Figure 2

**STEP FIVE:** The panel requires a minimum of nine fasteners per panel. The center hole must be fastened first. Fasteners then must be placed in the far left and far right nailing slots. Then attach 3 fasteners evenly spaced to the left of the center hole and 3 evenly spaced to the right of the center hole. Remember, fasteners must be placed in the center of the nailing slots. Additional fasteners may be required for high velocity wind areas. The non-corrosive fasteners must be installed into a solid substrate of no less than 7/16" thick. When attaching the fasteners, be sure they only lightly touch the panel allowing it to move with varying temperatures. The fastener must be installed flush with the panel, so as not to interfere with the succeeding row of panels.

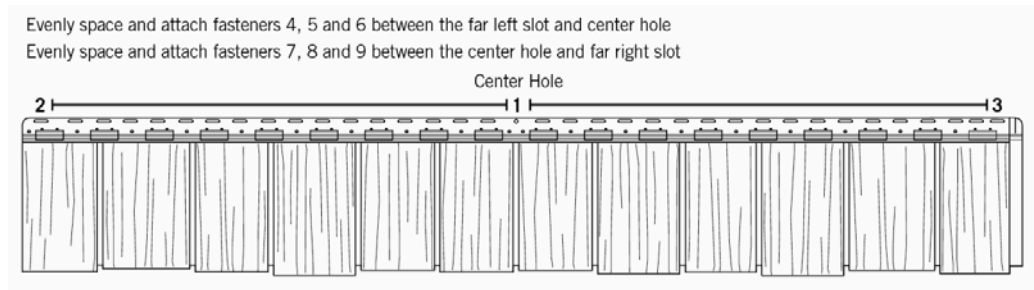

Figure 3

**STEP SIX:** Exteria provides stop posts 1/8" below the top edge of the installation fingers. Do not force the panels beyond the stop posts when installation succeeding rows of panels. The stops are designed to prevent buckling due to changing temperatures.

**STEP SEVEN:** For all succeeding panels of the present row, simply position the panel approximately 2 inches below the previous panel and slide upward making sure to engage the fingers and the bottom locking rail (Figure 4).

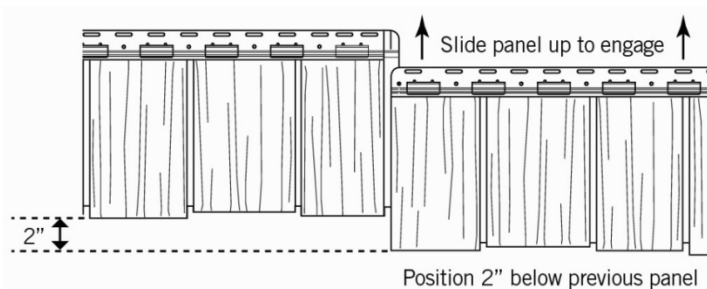

Figure 4

**STEP EIGHT:** Repeat Steps Four through Seven to complete the row.

**STEP NINE:** For all succeeding courses, simply position the panel approximately 2 inches below the previous panel and slide upward making sure to engage the fingers and the bottom locking rail. Repeat Steps Five through Seven to complete the row. Exteria provides a horizontal alignment line on the lower right side of each panel. Refer to this line to ensure that the heights of the panels are consistent. Be sure not to overlap the seams of the panel below to ensure an authentic look (Figure 5). To achieve the desired look, it is recommended to randomly select a shingle on the panel and

cut the shingle in half for all alternating rows. Be sure that the right end piece of the row is no less than 8" wide.

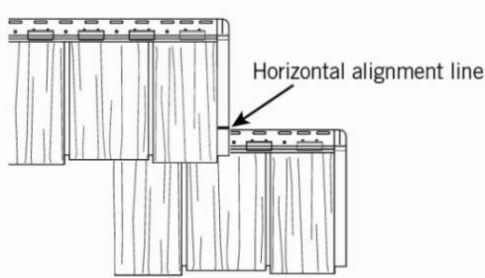

Figure 5

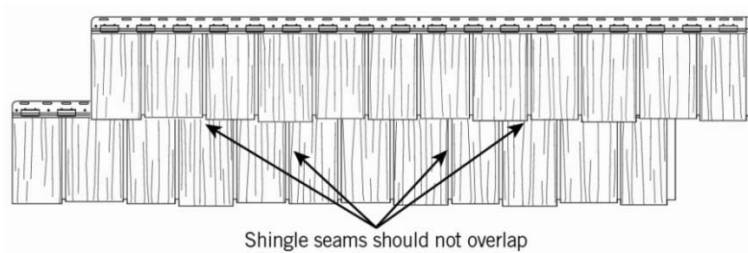

Figure 6

**STEP TEN:** Exteria ¾" J-Channels may be used for inside corner treatments. It is recommended to sleeve the corner with vinyl or aluminum coil prior to installation of panels (Figures 7 and 8).

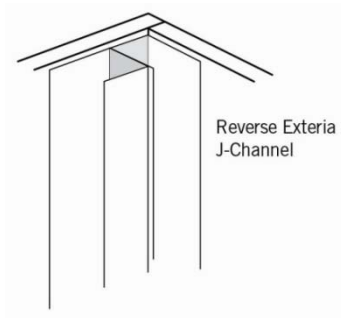

Figure 7

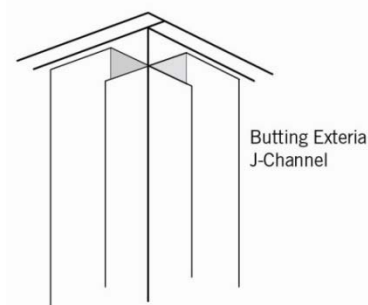

Figure 8

## CEDAR PRIDE INDIVIDUAL MOLDED CORNER INSTALLATION

The siding must be installed on all walls prior to installing the corners.

**STEP ONE:** Be sure the starter clip is affixed at the bottom of the wall's corner. Slide your first Cedar Pride molded corner over the siding and engage it into the starter clip (Figure 1b). Note that the top edge of the corner slides under the panel above it. The corner offers two fastening positions to choose from. For fasteners, galvanized screws are recommended. Once positioned properly, insert one fastener on each side (Figures 9 and 10).

NOTE: The bottom edge of the first installed corner extends below the starter clip.

**STEP TWO:** Take the next corner and engage it into the corner below. Be sure to slide the top of the corner into the row of siding above it and insert a fastener in each side. Gently tug the bottom of the corner to ensure it is properly engaged. Repeat this step until the corner installation is complete.

NOTE: *The last corner on the top of the row may have to be cut to adjust to the height of the corner. Corner/panel alignment will vary based on the realistic, staggered bottom edges of the panel.*

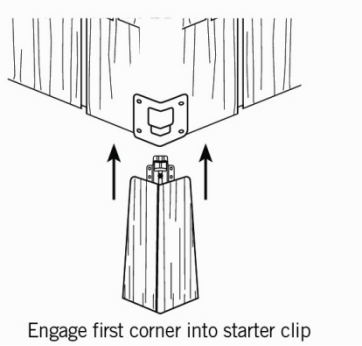

Figure 9

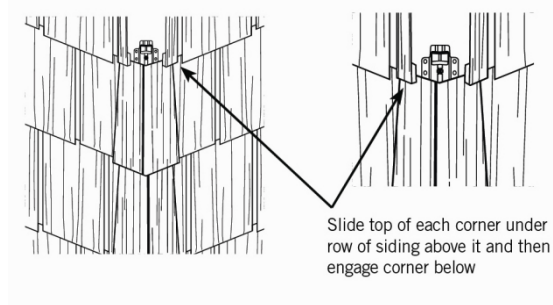

Figure 10

**REMINDERS:**

Some adjustment may need to be made at the vertical overlap of two corners (as they are installed) in order to maintain the corner/panel horizontal alignment. There is approximately a 1/2" vertical adjustment available.

Fitting panels between windows or around openings requires a cut-back spacing of approximately 1/8" to allow for product expansion.

**ATTACHING OBJECTS TO PANELS**

Never attach fixtures directly to Exteria siding. When attaching fixtures, use a block and follow the fixture manufacturer's installation instructions.

**SPECIAL SITUATIONS AND SUGGESTIONS**

**SITUATION**

1. Panels won't lock together side to side
2. The bottom locking fingers won't lock into the previous row.
3. Panels are buckling on the wall.
4. Panels are not laying down flat.

**ITEMS TO CHECK**

The wall may not be level and flat. Check previous panels to ensure that all panels and installation fingers are properly seated. (See Basic Guidelines)

Make sure the nails are not restricting panel movement. Make sure all fingers are engaged into corresponding rails.