

Porch Posts .....	184
Columns .....	186
Lamp Post .....	188
Timber Column.....	188
Timber Post Wrap .....	189
Stone Half-Round Columns .....	189



## Timeless Beauty

### Porch Posts, Columns & Wraps

Fypon® structural porch posts and columns provide the perfect combination of classic beauty and strength. Our porch posts and columns are designed to be beautiful, as well as strong, with high-density polyurethane construction and structural reinforcement. Alternatively, if you've already met the structural requirements of your project, Fypon decorative wraps can add the perfect finishing touch. Designed to install easily around an existing structural support, Fypon decorative wraps allow you to add the aesthetic appeal of decorative porch posts and columns near the end of your project. **For installation instructions, please visit [www.fypon.com](http://www.fypon.com).**

Products shown: COL11X96FSQ

## How to Use This Section

The products in this section of the catalog are organized by style. Where applicable, matching caps and bases are shown with the product.

## How to Order

The first step is to determine whether you need load-bearing porch posts and columns, or a decorative wrap to conceal an existing structural post.



## Structural Porch Posts & Columns\*\*

Structural porch posts and columns are reinforced and have load-bearing capacities up to 12,000 pounds. Installation hardware is included for easy ordering. Simply choose the style of column or porch post desired in a height that is equal to or slightly larger than the required height. Porch posts and columns can be trimmed to various lengths without affecting load rating. Be sure to order the appropriate quantity of porch posts and columns to adequately support the weight of the load they will carry.

## Decorative Wraps

Decorative wraps are non-structural and simply wrap an existing 4" x 4" treated wood post or other structural support. The decorative post wrap shown in this section is a 2-piece kit that includes 3-sided wrap and backer. We also carry a full line of PVC column wraps. For our PVC Catalog, please visit [www.fypon.com](http://www.fypon.com).

## Column & Wrap Accessories

Caps and bases are available as decorative accessories to help you achieve your desired look. These accessories are unattached and must be ordered separately.

### Remember to Order Adhesive

A urethane-based adhesive **must** be used on all joint surfaces. See page 190 to order Loctite® PL Premium® Adhesive.\*

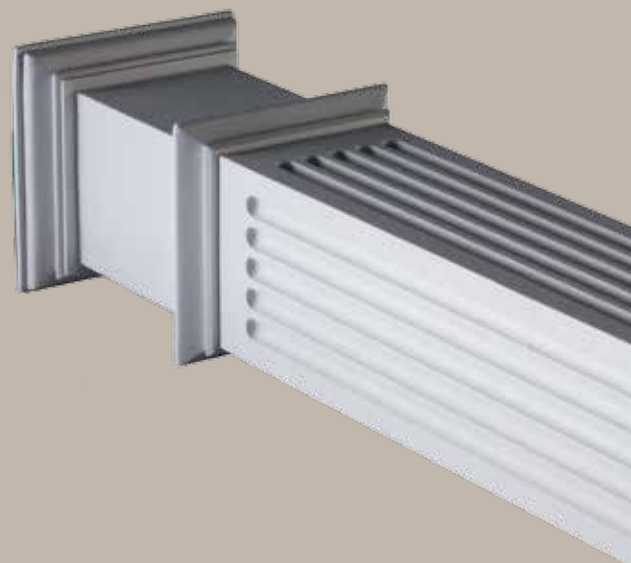

\* Loctite® PL Premium® is owned by Henkel Corporation.

\*\* Always consult the local building code authority to determine suitability of products to meet specific project requirements. Fypon reserves the right to hollow out the back of any product without notice. Some products may be made as assemblies.

# Colonial Porch Post

Structural

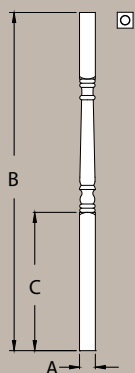

Part Number	Width (A)	Overall Height (B)	Bottom Block Height (C)	Load Bearing Capacity	Balustrade System
PP5X102	4 3/4"	101 5/16"	41 7/16"	6,000#	5" System
PP6X96	5 1/2"	96"	44 7/16"	6,000#	5" System
PP6X108	5 1/2"	108"	44 1/2"	6,000#	5" System
PP6X120	5 1/2"	120"	44 1/2"	6,000#	5" System
PP8X96	7 1/2"	96"	44 7/16"	12,000#	7" System

NOTE: Installation kit included. Porch posts can be field trimmed to various heights without losing load rating.

# Porch Post

Structural

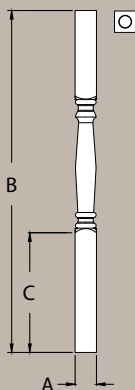

Part Number	Width (A)	Overall Height (B)	Bottom Block Height (C)	Load Bearing Capacity	Balustrade System
PP8X120A	7 1/2"	120"	42"	12,000#	7" System

NOTE: Installation kit included. Porch posts can be field trimmed to various heights without losing load rating.



# Fluted Porch Post

Structural

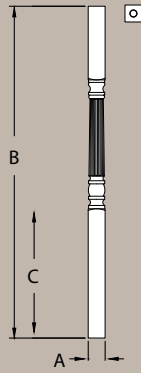

Part Number	Width (A)	Overall Height (B)	Bottom Block Height (C)	Load Bearing Capacity	Balustrade System
PP5X108F	5 1/2"	108"	42 1/8"	6,000#	5" System

NOTE: Installation kit included. Porch posts can be field trimmed to various heights without losing load rating.



# Fluted Porch Post

Structural

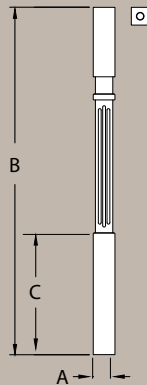

Part Number	Width (A)	Overall Height (B)	Bottom Block Height (C)	Load Bearing Capacity	Balustrade System
PPF8X120	7 1/2"	120"	42"	12,000#	7" System

NOTE: Installation kit included. Porch posts can be field trimmed to various heights without losing load rating.



# Plain Square Porch Post

Structural

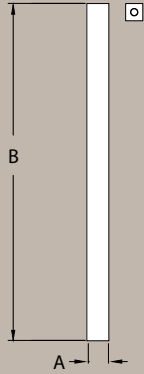

Part Number	Width (A)	Height (B)	Load Bearing Capacity	Balustrade System
PP6X96FBSQ	5 1/2"	96"	12,000#	5" System

NOTE: Installation kit included. Porch posts can be field trimmed to various heights without losing load rating.

# Fluted Square Column

Structural

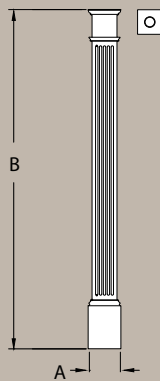

Part Number	Width (A)	Base / Cap Width	Height (B)	Base Height	Load Bearing Capacity
COL8X96FSQ	6"	8"	96"	13 1/2"	12,000#
COL11X96FSQ	8"	10 1/2"	96"	13 3/4"	12,000#
COL11X108FSQ	8"	10 5/8"	108"	13 1/4"	12,000#

NOTE: Installation kit included.



# Plain Square Column

Structural

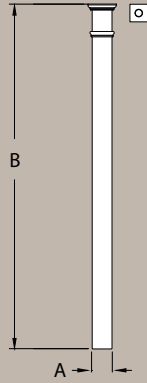

Part Number	Width (A)	Cap Width	Height (B)	Load Bearing Capacity
COL8X96FBTSQ	5 1/2"	8"	96"	12,000#

NOTE: Installation kit included.

# Panel Square Column

Structural

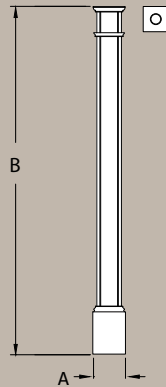

Part Number	Width (A)	Base / Cap Width	Height (B)	Base Height	Load Bearing Capacity
COL8X96PSQ	6 1/8"	8"	96"	13 5/8"	12,000#
COL11X96PSQ	8"	10 1/2"	96"	13 3/4"	12,000#
COL11X108PSQ	8"	10 5/8"	108"	12 3/4"	12,000#

NOTE: Installation kit included.



# Serpentine Column

*Structural*

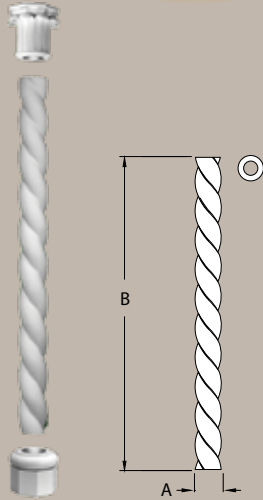

Part Number	Diameter (A)	Height (B)	Overall Width	Load Bearing Capacity
COL8X96SPN Column Shaft	8"	96"	—	12,000#
CC8SPN Deco Cap	11 3/16"	15 3/4"	16 13/16"	—
CB8SPN Deco Base	9 1/4"	7 11/16"	10 7/16"	—

NOTE: Installation kit included.

# Lamp Post

*Non-Structural / Decorative*

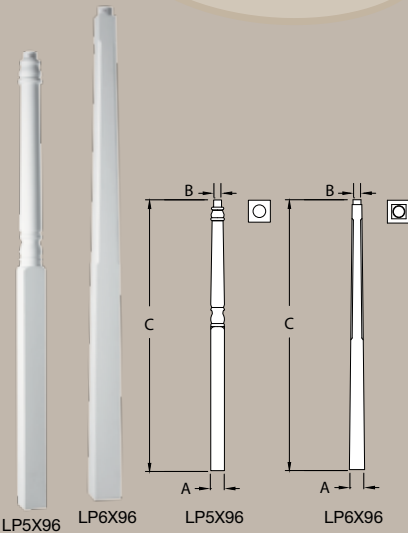

Part Number	Bottom Width (A)	Top Width (B)	Height (C)	Pipe Diameter
LP5X96	5"	4 1/2"	96"	2 7/8"
LP6X96	5 1/2"	3 1/2"	96"	2 7/8"

NOTE: Non-structural pipe extends 1 3/4" beyond top of post.

# Timber Column

*Structural / Stainable*

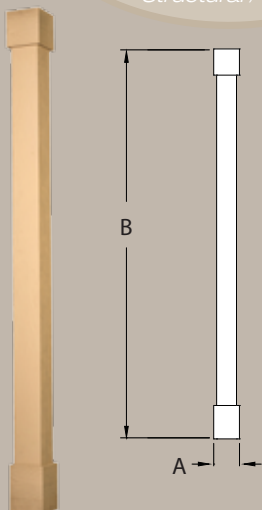

Part Number	Width (A)	Height (B)	Load Bearing Capacity
PPSQKIT6X108S <b>NEW</b>	7"	108"	12,000#

NOTE: Installation kit included. Column can be field trimmed to various heights without losing load rating.

# Timber Post Wrap

*Stainable*

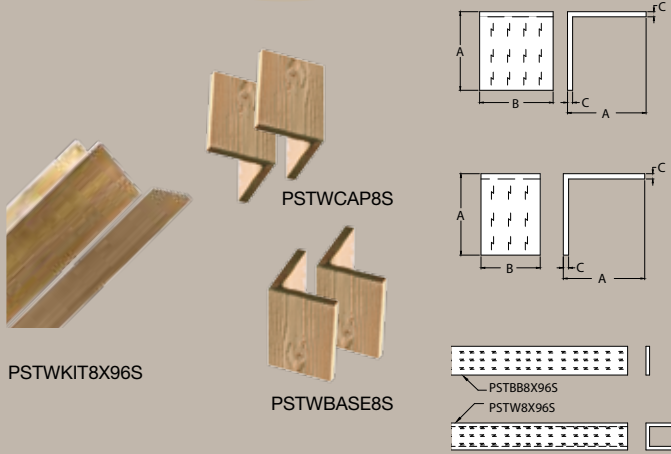

Part Number	Width (A)	Height (B)	Thickness (C)
<b>PSTWBASE8S</b> Post Wrap Base Ships in 2 L-shaped halves	9 5/8"	9"	5/8"
<b>PSTWCAP8S</b> Post Wrap Cap Ships in 2 L-shaped halves	9 5/8"	7"	5/8"
<b>PSTWKIT8X96S</b> Post Wrap Kit Ships in 2 pieces Dimensions are assembled size.	7 1/2" x 9"	96"	1"

**Kit Contents:**  
 (1) 3-Sided Wrap  
 (1) Backer

# Stone Half-Round Column

*Non-structural / Decorative*

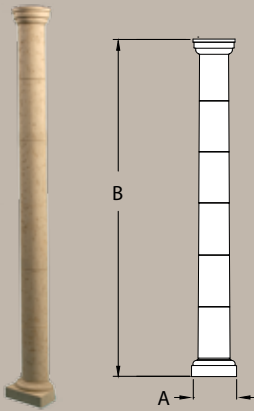

Part Number	Width (A)	Height (B)	Projection
<b>HRC15X168ST</b> Non-Tapered Kit Kit ships in 4 pieces and creates one half column. Order two kits to create a full column.	15"	167 3/16"	7 1/2"

**Kit Contents:**  
 (1) Cap Half  
 (1) Shaft Top Half  
 (1) Shaft Bottom Half  
 (1) Base Half

# Stone Half-Round Column

*Non-structural / Decorative*

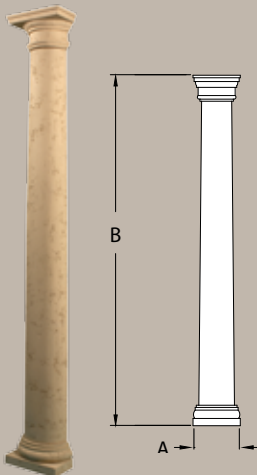

Part Number	Width (A)	Height (B)	Projection
<b>HRCBCC96X12ST</b> Tapered Kit Kit ships in 3 pieces and creates one half column. Order two kits to create a full column.	14 15/16"	110 1/4"	11 3/4"

**Kit Contents:**  
 (1) Cap Half  
 (1) Shaft Half  
 (1) Base Half